

N-Channel Enhancement Mode Field Effect Transistor

DFN5X6

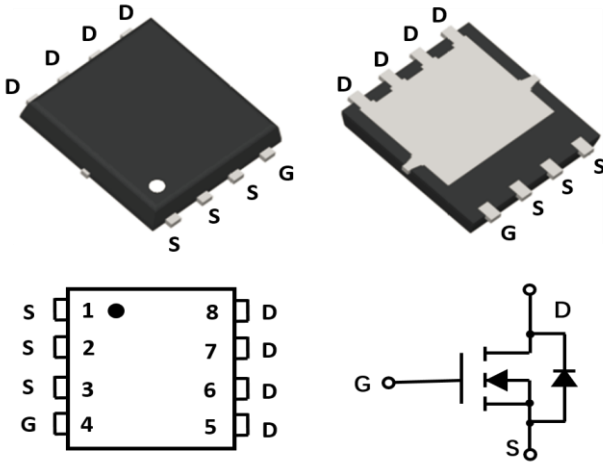

Product Summary

- V_{DS} 60V
- I_D 20A
- $R_{DS(ON)}$ (at $V_{GS}=10V$) < 35 mohm
- $R_{DS(ON)}$ (at $V_{GS}=4.5V$) < 45 mohm
- 100% UIS Tested
- 100% ∇V_{DS} Tested

General Description

- Trench Power MV MOSFET technology
- Excellent package for heat dissipation
- High density cell design for low $R_{DS(ON)}$

Applications

- DC-DC Converters
- Power management functions
- Backlighting

■ Absolute Maximum Ratings ($T_A=25^\circ C$ unless otherwise noted)

Parameter	Symbol	Limit	Unit
Drain-source Voltage	V_{DS}	60	V
Gate-source Voltage	V_{GS}	± 20	V
Drain Current	I_D	$T_C=25^\circ C$	20
		$T_C=100^\circ C$	12.5
Pulsed Drain Current ^A	I_{DM}	60	A
Total Power Dissipation @ $T_C=25^\circ C$	P_D	41	W
Single Pulse Avalanche Energy ^B	E_{AS}	20	mJ
Thermal Resistance Junction-to-Case	$R_{\theta JC}$	3.0	$^\circ C/W$
Junction and Storage Temperature Range	T_J, T_{STG}	-55~+150	$^\circ C$

■ Ordering Information (Example)

PREFERRED P/N	PACKING CODE	Marking	MINIMUM PACKAGE(pcs)	INNER BOX QUANTITY(pcs)	OUTER CARTON QUANTITY(pcs)	DELIVERY MODE
YJG20N06A	F2	YJG20N06A	2500	2500	25000	13" reel



YJG20N06A

■ Electrical Characteristics ($T_J=25^\circ\text{C}$ unless otherwise noted)

Parameter	Symbol	Conditions	Min	Typ	Max	Units
Static Parameter						
Drain-Source Breakdown Voltage	BV_{DSS}	$V_{GS}=0V, I_D=250\mu A$	60			V
Zero Gate Voltage Drain Current	I_{DSS}	$V_{DS}=60V, V_{GS}=0V$			1	μA
Gate-Body Leakage Current	I_{GSS}	$V_{GS}=\pm 20V, V_{DS}=0V$			± 100	nA
Gate Threshold Voltage	$V_{GS(th)}$	$V_{DS}=V_{GS}, I_D=250\mu A$	0.7	1.3	2	V
Static Drain-Source On-Resistance	$R_{DS(on)}$	$V_{GS}=10V, I_D=20A$		32	35	m Ω
		$V_{GS}=4.5V, I_D=10A$		35	45	
Diode Forward Voltage	V_{SD}	$I_S=10A, V_{GS}=0V$		0.8	1.2	V
Maximum Body-Diode Continuous Current	I_S				20	A
Dynamic Parameters						
Input Capacitance	C_{iss}	$V_{DS}=30V, V_{GS}=0V, f=1\text{MHz}$		800		pF
Output Capacitance	C_{oss}			68		
Reverse Transfer Capacitance	C_{rss}			36		
Switching Parameters						
Total Gate Charge	Q_g	$V_{GS}=10V, V_{DS}=30V, I_D=10A$		15		nC
Gate-Source Charge	Q_{gs}			2.4		
Gate-Drain Charge	Q_{gd}			2.5		
Reverse Recovery Charge	Q_{rr}	$I_F=20A, di/dt=500A/\mu s$		23		nC
Reverse Recovery Time	t_{rr}			45		
Turn-on Delay Time	$t_{D(on)}$	$V_{GS}=10V, V_{DD}=30V, I_D=2A, R_L=1\Omega$ $R_{GEN}=3\Omega$		5		ns
Turn-on Rise Time	t_r			39		
Turn-off Delay Time	$t_{D(off)}$			19		
Turn-off fall Time	t_f			7		

A. Pulse Test: Pulse Width $\leq 300\mu s$, Duty cycle $\leq 2\%$.

B. $T_J=25^\circ\text{C}$, $V_{DD}=30V$, $V_G=10V$, $L=0.5\text{mH}$, $R_g=25\Omega$



■ Typical Performance Characteristics

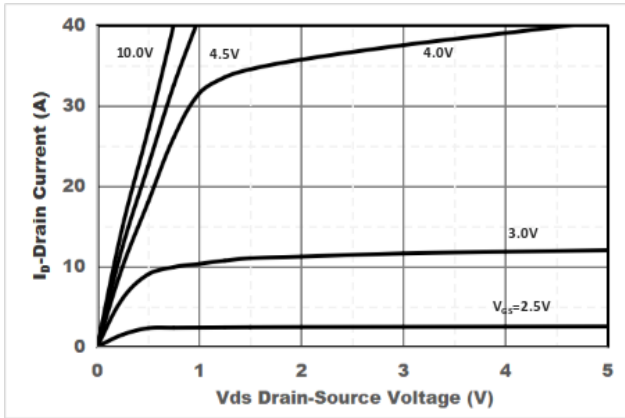

Figure1. Output Characteristics

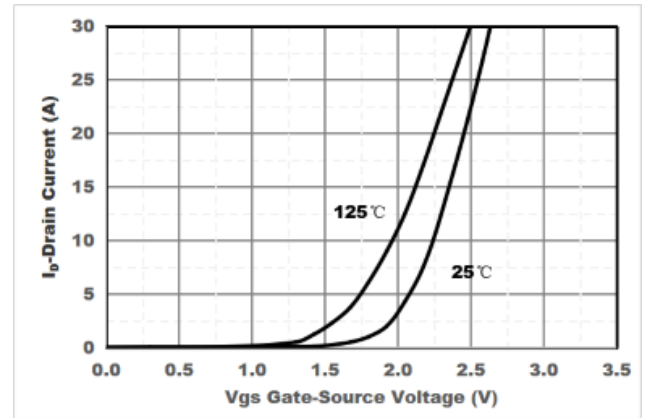

Figure2. Transfer Characteristics

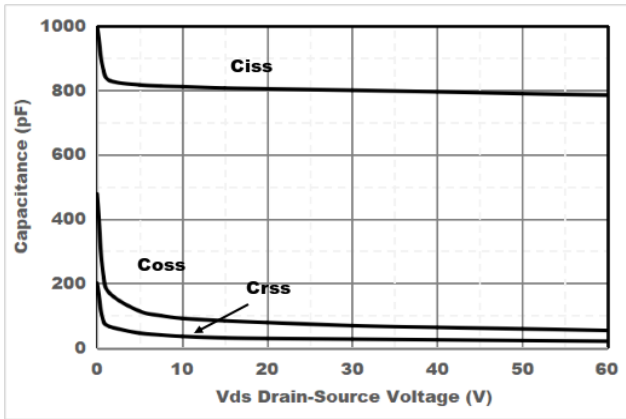

Figure3. Capacitance Characteristics

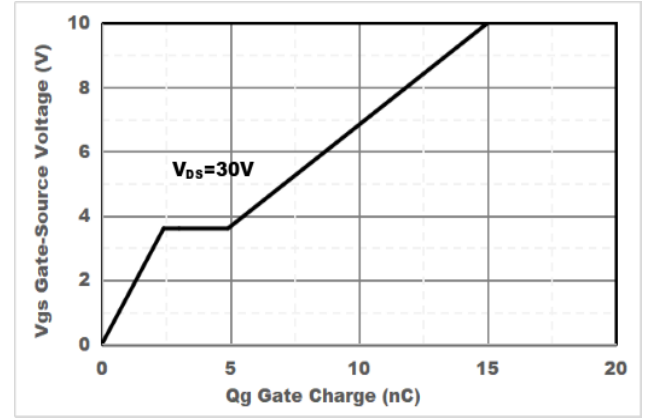

Figure4. Gate Charge

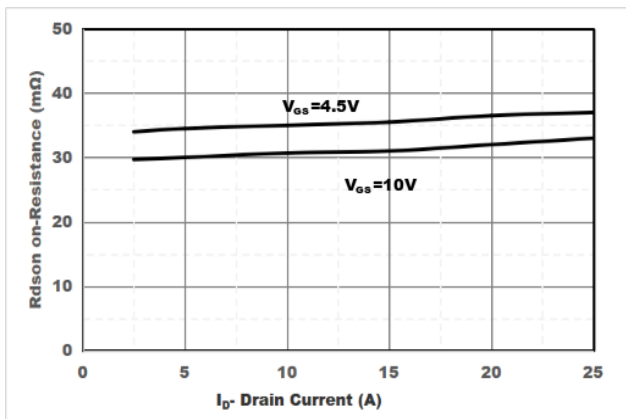

Figure5. Drain-Source on Resistance

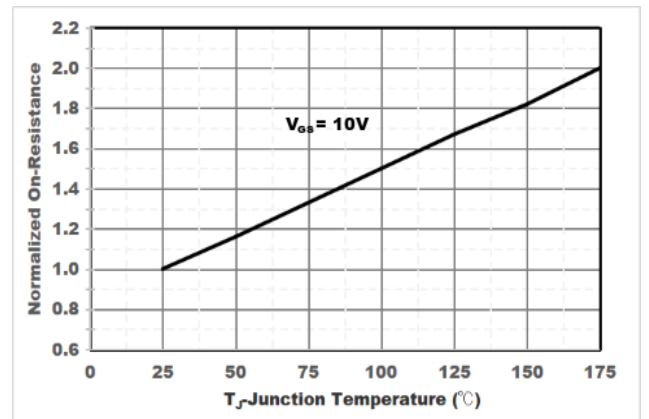

Figure6. Drain-Source on Resistance

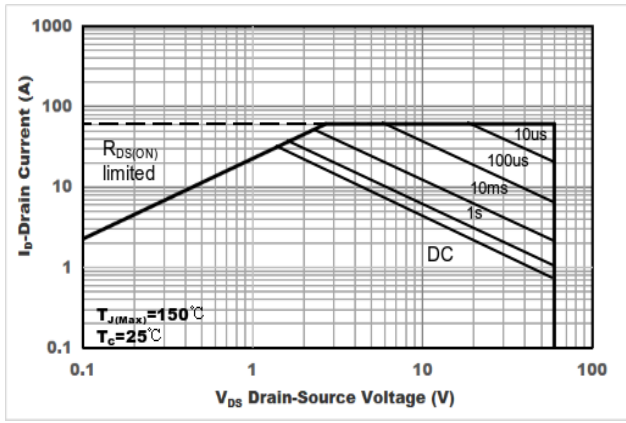

Figure7. Safe Operation Area

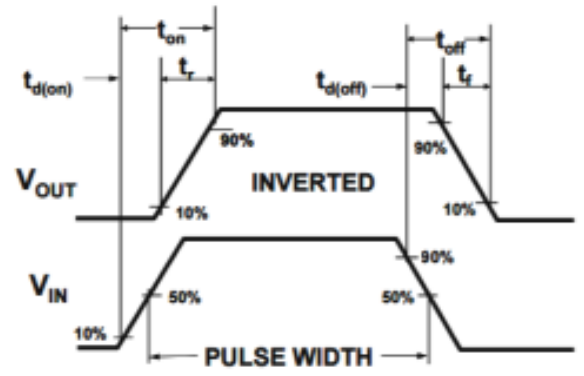
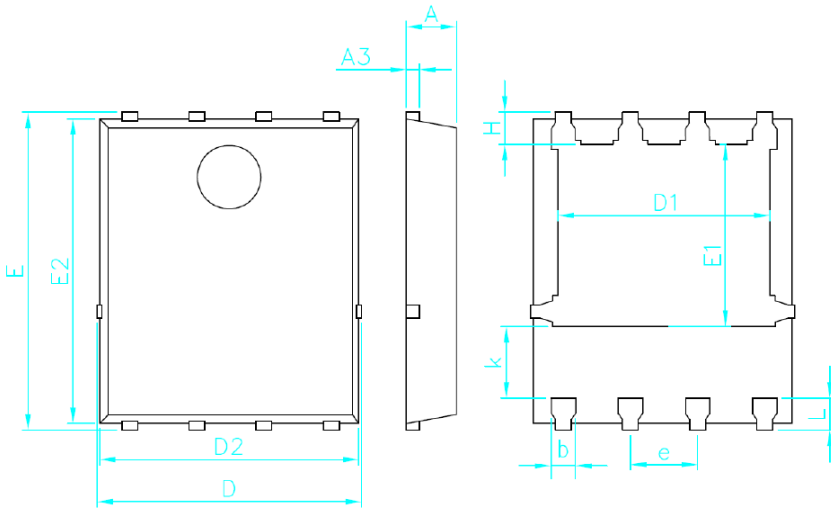

Figure8. Switching wave



YJG20N06A

■ DFN5X6 Package information



Symbol	Min	Typ.	Max
A	0.900	0.950	1.000
A3	0.254REF.		
D	4.900	5.000	5.100
E	5.900	6.000	6.100
D1	3.750	3.950	4.150
E1	3.300	3.450	3.600
D2	4.800	4.900	5.000
E2	5.650	5.750	5.850
k	1.200	1.350	1.500
b	0.350	0.400	0.450
e	1.220	1.270	1.320
L	0.510	0.610	0.710
H	0.510	0.610	0.710



YJG20N06A

Disclaimer

The information presented in this document is for reference only. Yangzhou Yangjie Electronic Technology Co., Ltd. reserves the right to make changes without notice for the specification of the products displayed herein to improve reliability, function or design or otherwise.

The product listed herein is designed to be used with ordinary electronic equipment or devices, and not designed to be used with equipment or devices which require high level of reliability and the malfunction of which would directly endanger human life (such as medical instruments, transportation equipment, aerospace machinery, nuclear-reactor controllers, fuel controllers and other safety devices), Yangjie or anyone on its behalf, assumes no responsibility or liability for any damages resulting from such improper use of sale.

This publication supersedes & replaces all information previously supplied. For additional information, please visit our website [http:// www.21yangjie.com](http://www.21yangjie.com) , or consult your nearest Yangjie's sales office for further assistance.